

HK 36 TPF

AERIAL PLATFORM



HIDROKON



Stability and Performance Together





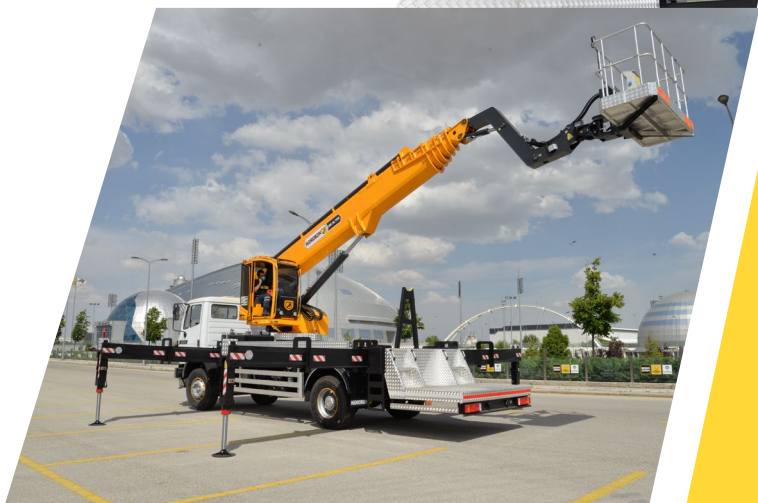



HK 36 TPF Aerial Platform

*With high quality equipment,
superior capability and
maximum safety features.*





Technical Specifications

	Total weight*	15000 kg		Rotation angle of the basket boom	90°
	Max. working height	36 m		Rotation angle of the basket	± 90°
	Max. basket height	34 m		Size of the basket	850x1100x2000 mm
	Max. outreach	25,5 m		Max. basket load	300 kg
	Rotation angle of turntable	± 270°	*It Varies Depending On The Vehicle Type.		

BASIC SPECIFICATIONS

ENGINE START/STOP IN CABIN	STANDARD
RAMPING ON MOVEMENT START AND STOP	STANDARD

BASKET

ENGINE START/STOP IN THE BASKET	STANDARD
220 V AC OUTLET	STANDARD
OVERLOAD CONTROL ON BASKET	STANDARD
LIGHTENING	STANDARD

BOOMS

MAINBOOM ANGLE	85 °
LENGTH AND ANGLE CONTROL OF BOOMS	STANDARD

SLEWING

SLEWING ANGLE CONTROL	STANDARD
SLEWING WITHIN THE VIEW OF THE SIDE MIRRORS	STANDARD

OUTRIGGERS

TWO OUTRIGGERS ON EACH SIDE	STANDARD
VERTICAL JACKING CONTROL	STANDARD
MAXIMUM PERMISSIBLE INCLINATION	3 °

OPTIONAL SPECIFICATIONS

TWO SECTION EXTENDABLE BASKET	OPTIONAL
BODY BY ALUMINIUM COVER	OPTIONAL
STABILIZER PADS	OPTIONAL

FEATURES

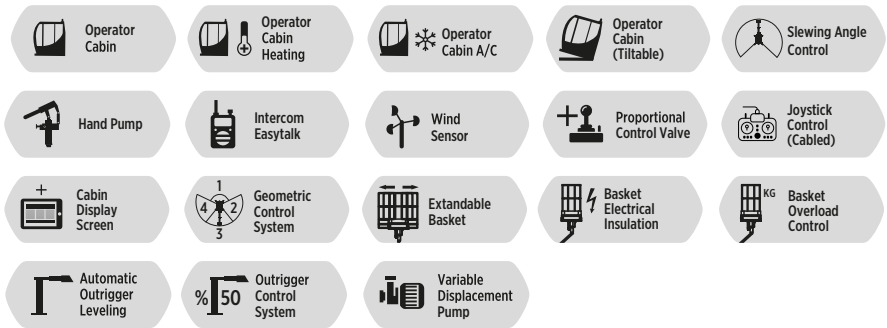

Dimensions (mm)

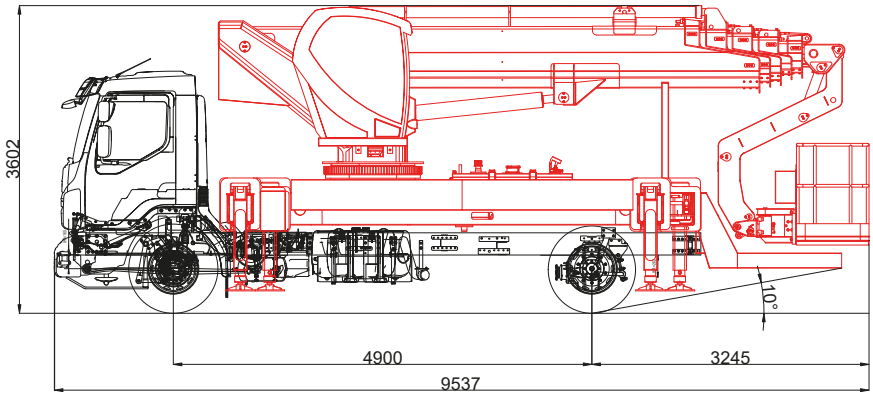

HK 36 TPF Working Diagrams

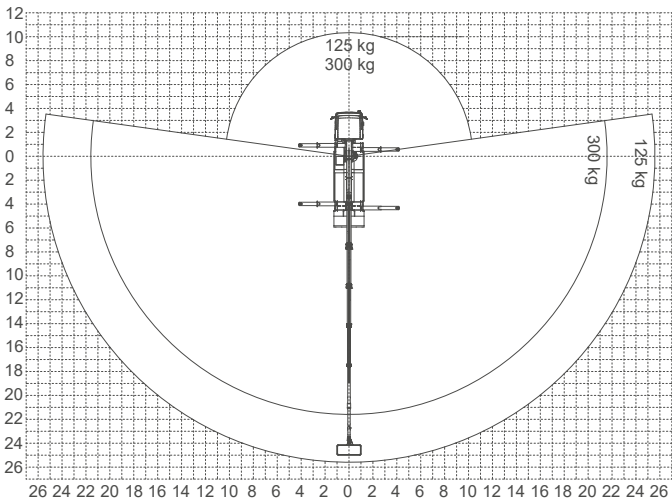
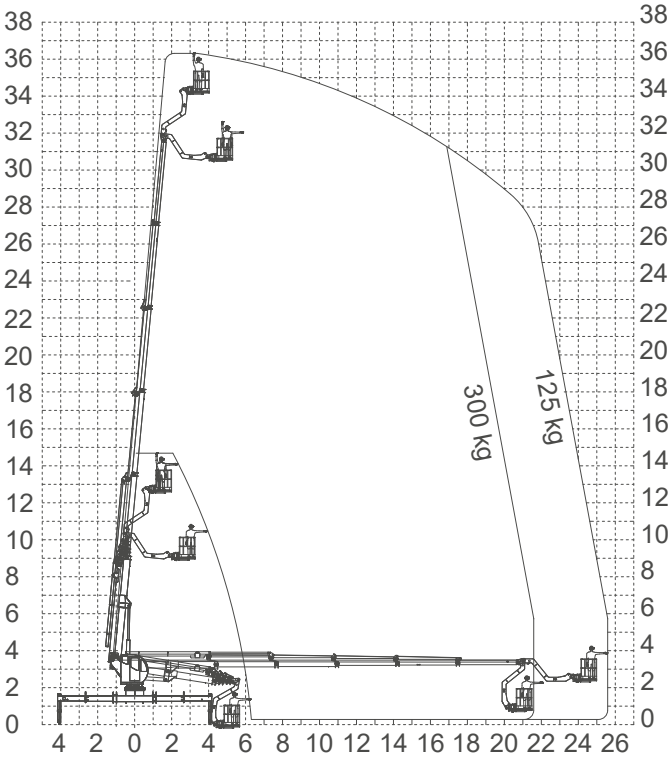

*Boom deflections are not taken into consideration