

HK 90 22 T2

TELESCOPIC CRANE



HIDROKON



Power is With You!

HK 90 22 T2 **Telescopic Crane**

*With high quality equipment,
superior capability and
maximum safety features.*





FEATURES



Operator
Cabin



Operator
Cabin
Heating



Operator
Cabin A/C



Joystick
Control



Operator
Cabin
(Tilttable)



Proportional
Control Valve



Crane
Radio Remote
Control



Outrigger
Radio Remote
Control



Automatic
Outrigger
Leveling



Outrigger
Control
System



KG
Load
Weighing
System



Variable
Displacement
Pump



Automatic
Lubrication



Counter
Weight

Specifications

Chassis

Frame

HIDROKON designed and manufactured, box type torsion resistant, made of high tensile structural steel.

Outriggers

H type four outriggers which are hydraulically operated by control levers. Control levers are located at the each side of the truck chassis.

Superstructure

Slewing System

Continuous slewing on ball bearing slewing ring. Process is operated by hydraulic motor driven planetary gear reducer. Slewing is possible continuously 360°.

- Slewing speed 1.5 min⁻¹

Operator Cabin

Ergonomic and comfortable design for optimum visibility. Cabin with heater and tilt function up to 25°.

Counterweight

Fixed counterweight of 3.75t.

Booms

Telescopic Booms

System consist of 1 basic boom and 2 telescopic boom sections. Hydraulically extendable and synchronized extension is on telescopic booms. Sections are made of high strength structural steel.

- Main boom length is 9.2 m – 22 m.
- Boom angle range is 0° - 82°.
- Main boom reaches 0° to 82° in 65 s.

Safety Devices

Load Weighing System, Load Moment System, anti-two block at boom head, pressure relief valves, dual overcenter valves.

System of the Display Screen consists of:

- Percentage of safe working limit that is utilized
- Audible and visual pre-warning for overload, max lifting, back stop (warning in accordance with anti-two block switch) and pre-alarm (buzzer alarm when the %75 lifting capacity is reached)
- Entry log for number of parts of line of hook block.
- Screen showing main boom angle, boom length, load radius, rated lifting capacities, measured load values and permissible load
- Net weight calculation in the case of equipment usage for load handling
- User is able to update time & date. Furthermore total working time is able to be set.

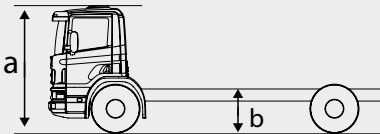

Crane Carrier

a: distance between carrier cab and floor level
b: distance between carrier chassis and floor level

6x4 vehicle, to be supplied by the customer.

Minimum wheelbase may vary depending on the vehicle.

Max a : 3000 mm

Max b : 1210 mm

General Notes

1. Load diagrams and load charts given only apply to the original HIDROKON manufactured models. Other party modifications or use of optional equipment may result in capacity reduction.
2. All the lifting capacities given are the maximum loads that are depending on the conditions when only the machine stands on steady supporting surface.
3. Load diagrams are set for %50 and %100 outrigger extension lengths. Crane may be used for load handling only when the outrigger extension is min %50 and any configuration in between %50 and %100, load diagram for %50 outrigger extension apply.

Critical Notes for Operational Safety

1. The load charts are calculated according to EN 13000.
2. Crane should only be operated for handling load purposes (operations stated in ISO 4301-1, crane group A1).
3. The lifting capacity is subject to the level of outrigger extension and position of the turret. Given lifting capacities are applicable for the back and sides of the truck.
4. Automatic outrigger leveling and geometric control system are optional specifications for the model. When the model does not have these two features, operator may work in front of the cab area. We do not recommend working with the main boom in front of the cab area. In the case of working in front of the cab area and / or on a surface where outrigger jacks are not balanced, all the responsibility belongs to the user.
5. Main winch capacity is 40 kN (4078 kg) per line. It should not be used to lift a load more than its capacity.

Dimensions (mm)

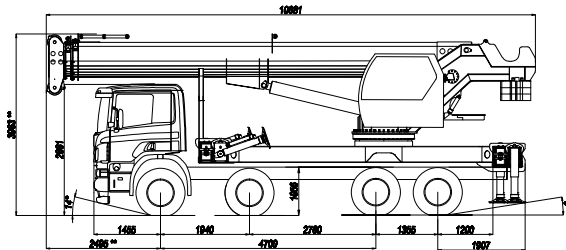

TRUCK: SCANIA P380 CB 8X4 EHZ
CRANE : HK 90 22 T2

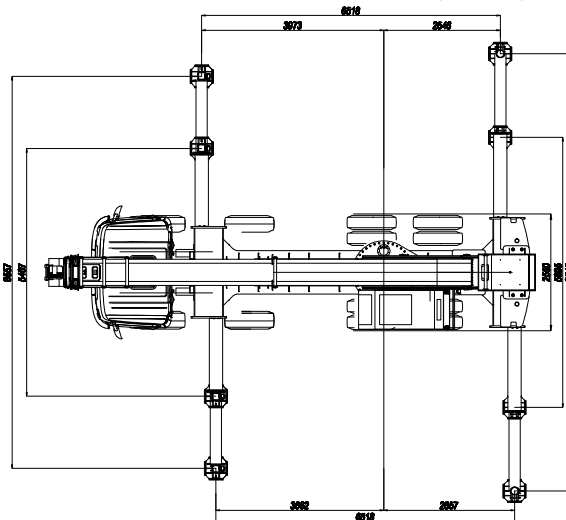

Technical Parameters

Category	Subject	Unit	Measure
Operating Performance	Max. technical lifting capacity	t	30
	Min. Rated working radius	m	3
	Basic boom max. height with load	m	9.2
	Main boom max. height with load	m	22
Operating Speed	Winch hoist rope max. speed	m/min	0-136 (4th layer)
	Time for max. boom elevation	s	65
	Time for max. main boom extension	s	50
	Slewing speed	r/min	0-1.5
Dimensions	Outrigger extension (Lateral)	m	Fully extended: 6.518
	Front Outrigger extension (Longitudinal)	m	Fully extended: 8.557 Half extended: 5.407
	Rear Outrigger extension (Longitudinal)	m	Fully extended: 9.545 Half extended: 5.895
	Main boom extension range	m	9.2 - 22
	Main boom angle range	°	0 - 82

*Rope speed is valid when the min. oil flow rate is 135 l/min.

Hook Capacity	No. of Sheaves	No. Of lines	Weight (kg)	Notes
30t	4	8	313	Single hook

Layer	Hydraulic Winch		
	Operating (Rope) Speed	Lifting Capacity	
	m/min**	kN	kg
1st	54 / 108	50.2	5118
2nd	59 / 117	46.3	4721
3rd	63 / 127	43	4384
4th	68 / 136	40	4078

**When pump delivery is 135 l/min.

Wire Rope Layer	Drum	
	14 mm wire rope	
	Rope per layer (m)	Total Wire Rope (m)
1	35.5	35.5
2	38.5	74
3	42	116
4	47	163

Lifting Heights

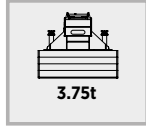
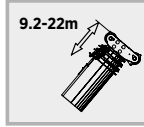
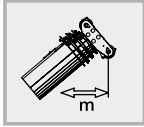
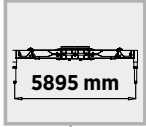

%50

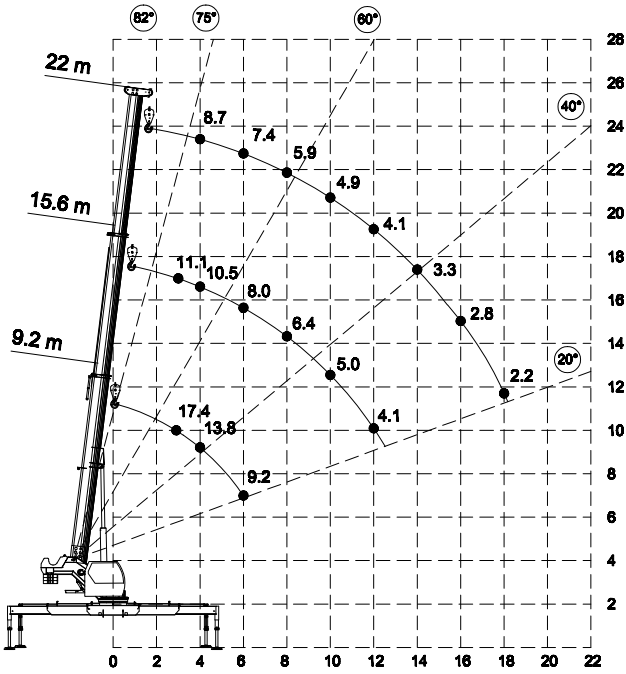

Boom Length	9.2 m	15.6 m	22 m
Radius			
3 m	17.4	11.1	
4 m	13.8	10.5	8.7
5 m	11.2	9.1	7.9
6 m	9.2	8.0	7.4
7 m		7.1	6.5
8 m		6.4	5.9
9 m		5.5	5.2
10 m		5.0	4.9
11 m		4.5	4.3
12 m		4.1	4.1
13 m			3.6
14 m			3.3
15 m			3.0
16 m			2.8
17 m			2.4
18 m			2.2
Boom Length	9.2 m	15.6 m	22 m

Lifting Heights

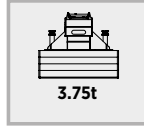
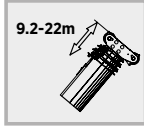
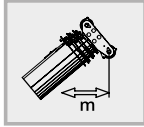
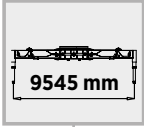

%100

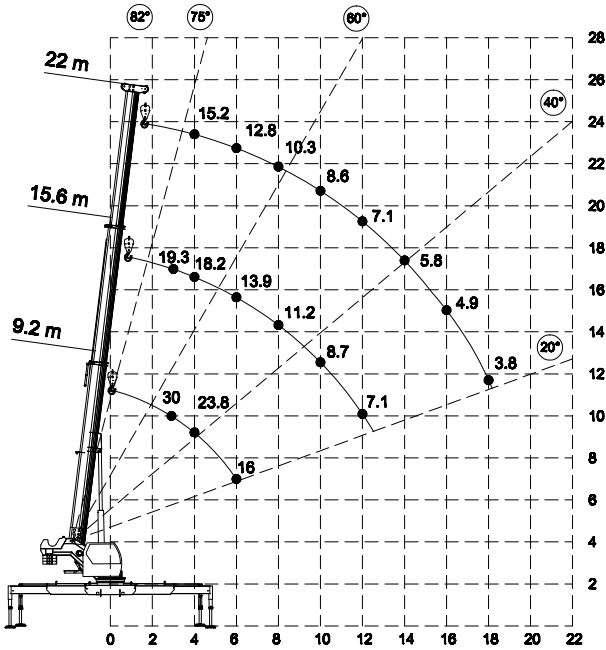

Boom Length	9.2 m	15.6 m	22 m
Radius			
3 m	30.0	19.3	
4 m	23.8	18.2	15.2
5 m	19.8	16.0	14.0
6 m	16.0	13.9	12.8
7 m		12.5	11.5
8 m		11.2	10.3
9 m		9.8	9.4
10 m		8.7	8.6
11 m		7.9	7.7
12 m		7.1	7.1
13 m			6.4
14 m			5.8
15 m			5.2
16 m			4.9
17 m			4.3
18 m			3.8
Boom Length	9.2 m	15.6 m	22 m